

# Metal Earth. LEGENDS

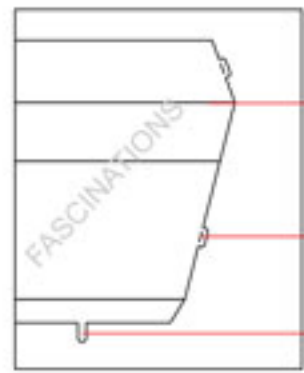

GAMORA

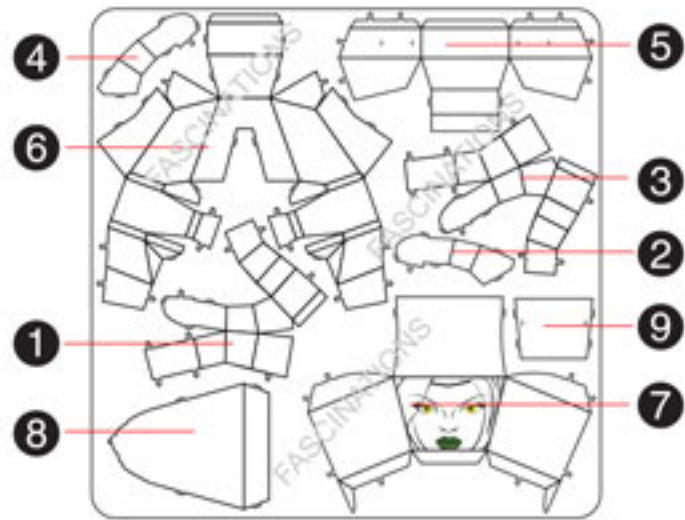

Fold lines can be seen as shown here

Insertion holes

Insertion tabs are inserted and then folded or twisted

Tweezers or needle nose pliers are helpful for assembly.

To create the best connections

● Insert tab and bend 90 degrees for most visible areas

▲ Insert tab and twist 90 degrees is best in some areas to ensure a tight connection

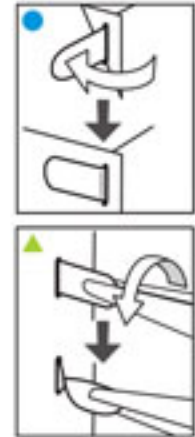

It is recommended that you visit [www.metalearth.com/help/mem010](http://www.metalearth.com/help/mem010) for more information when assembling this model.

⚠ In order to avoid possible injury from sharp edges, please carefully discard the metal sheet after parts have been removed

## Assembly Flow Chart

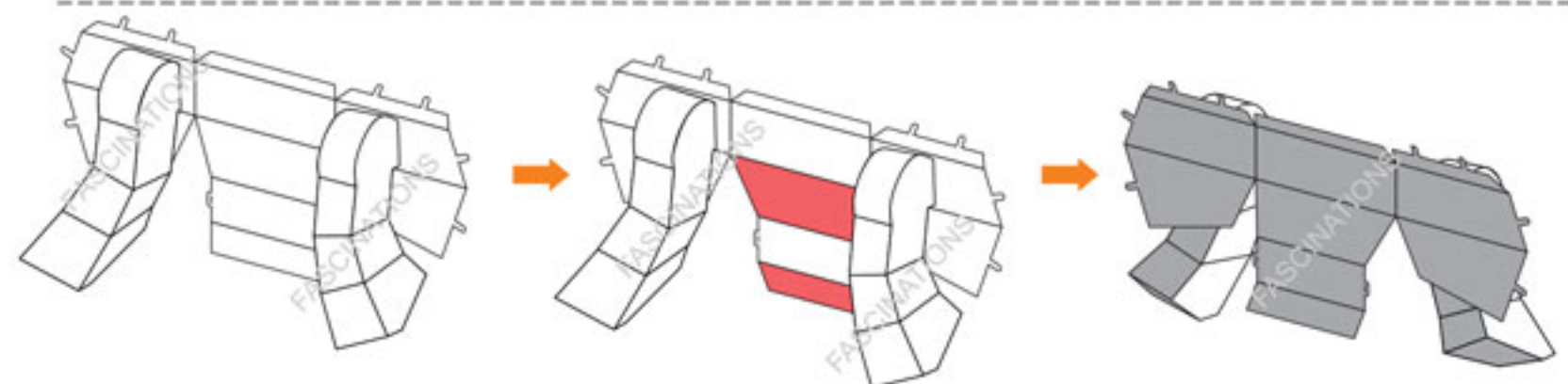
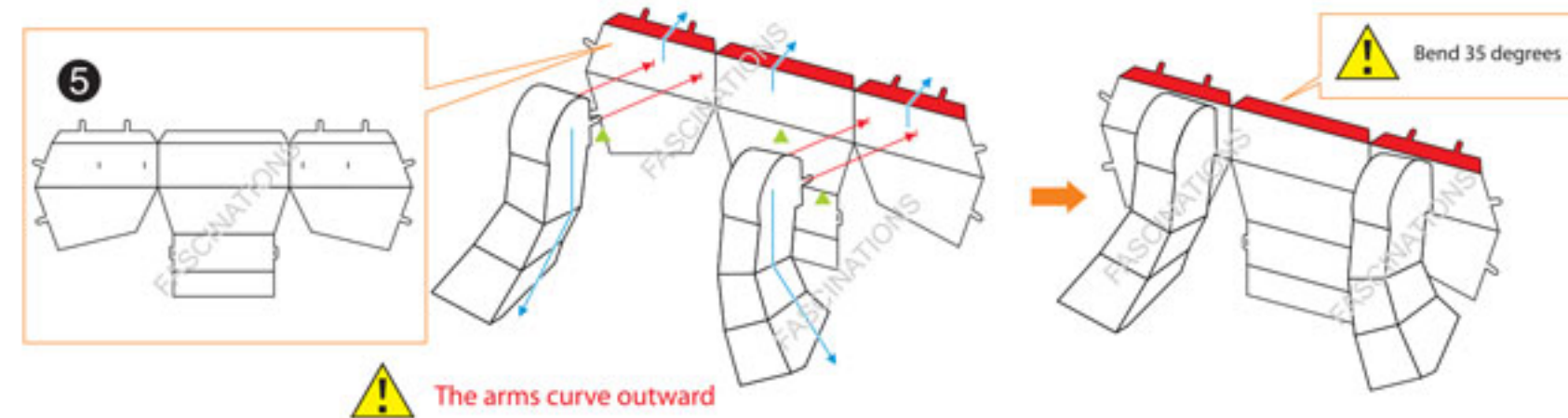
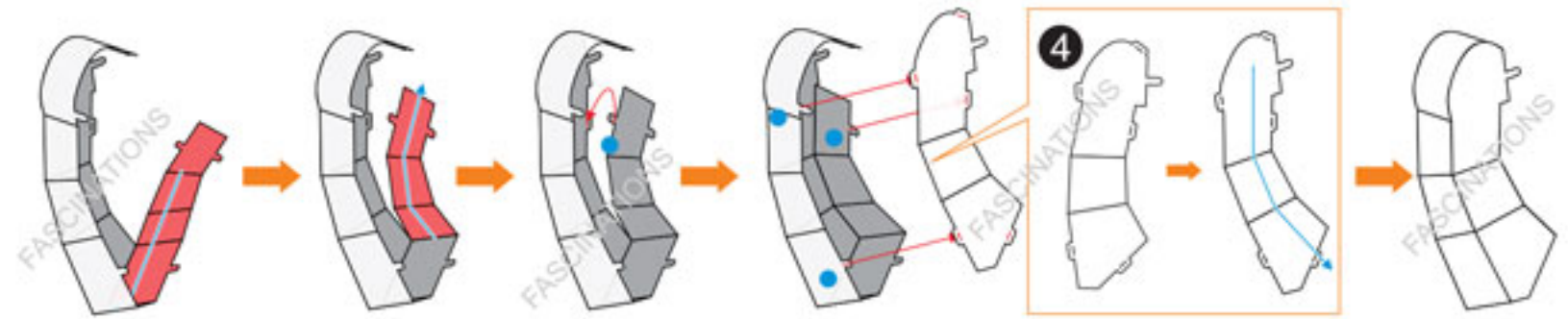
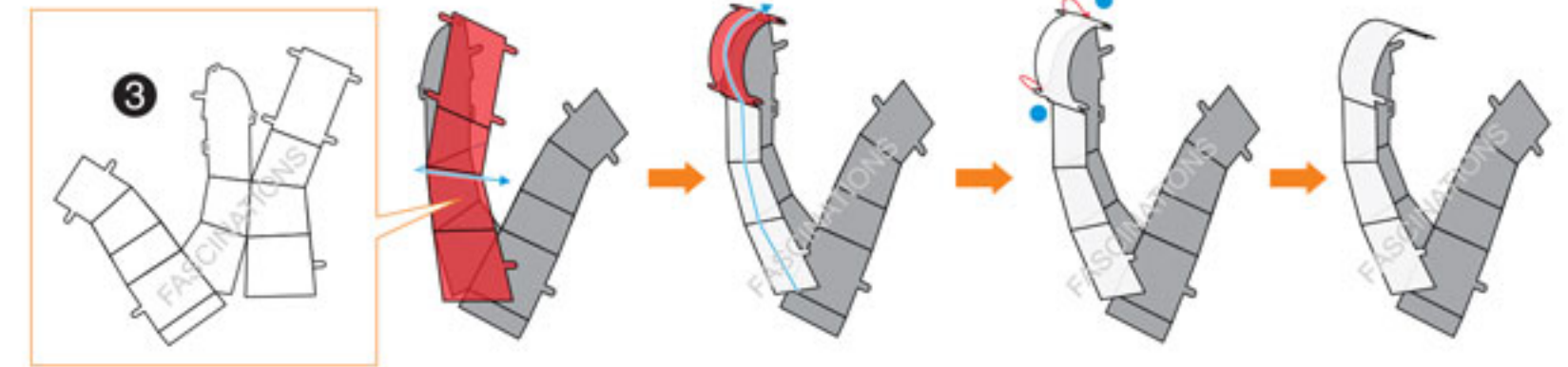
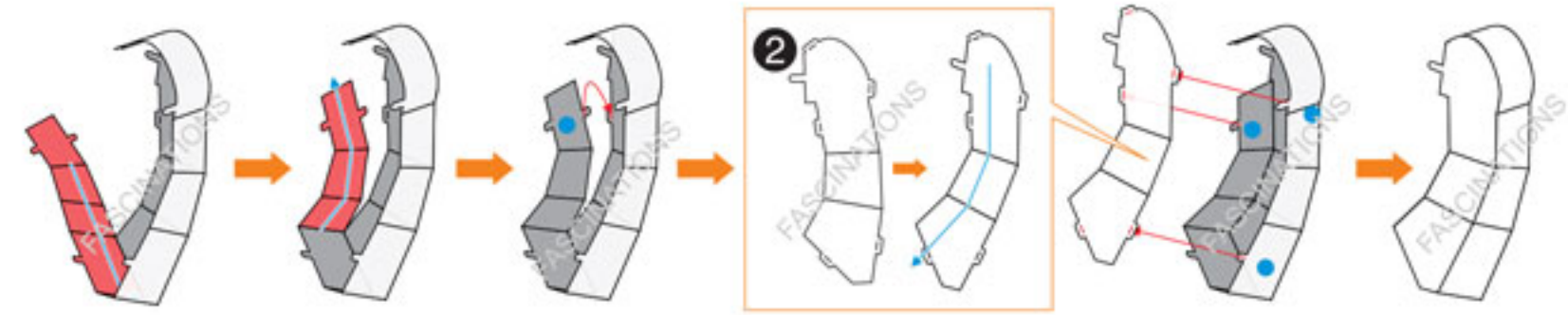
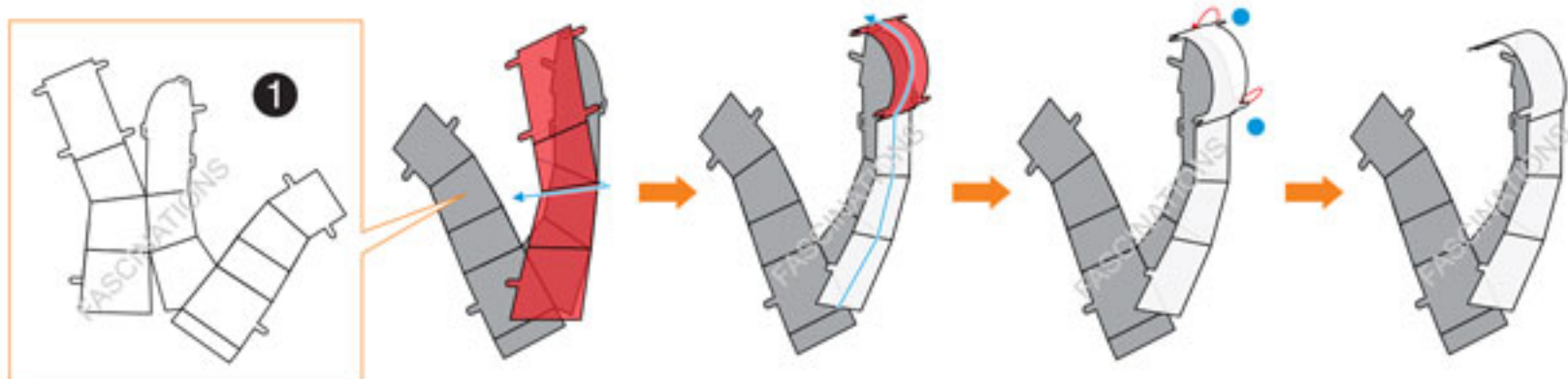



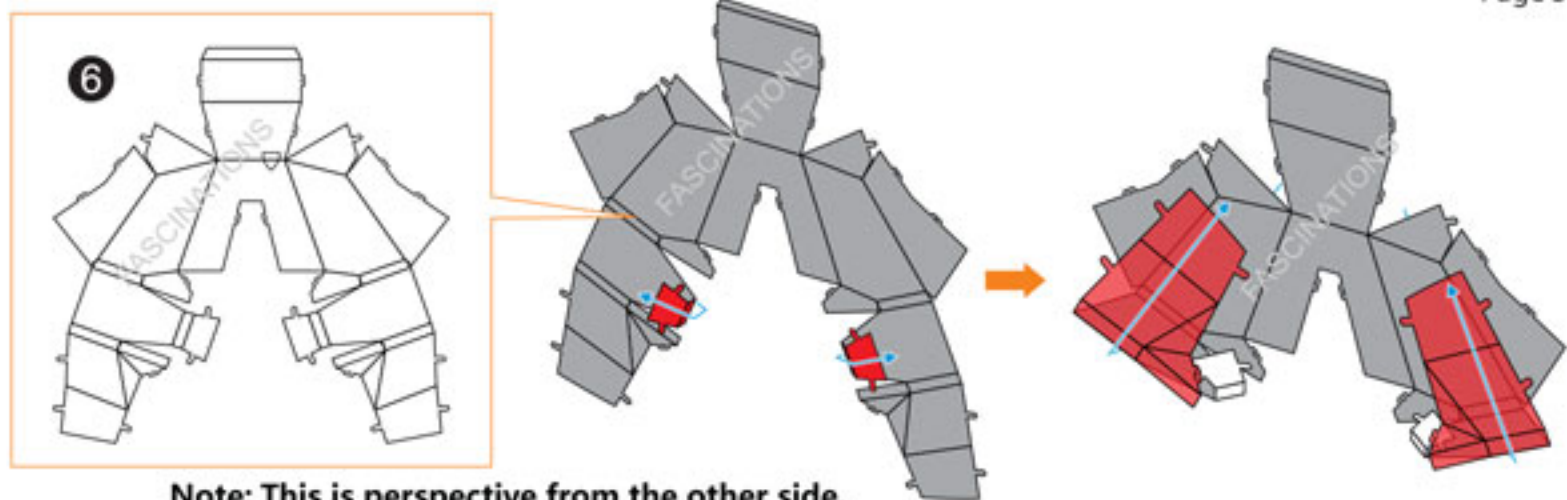

Note: This is perspective from the other side.

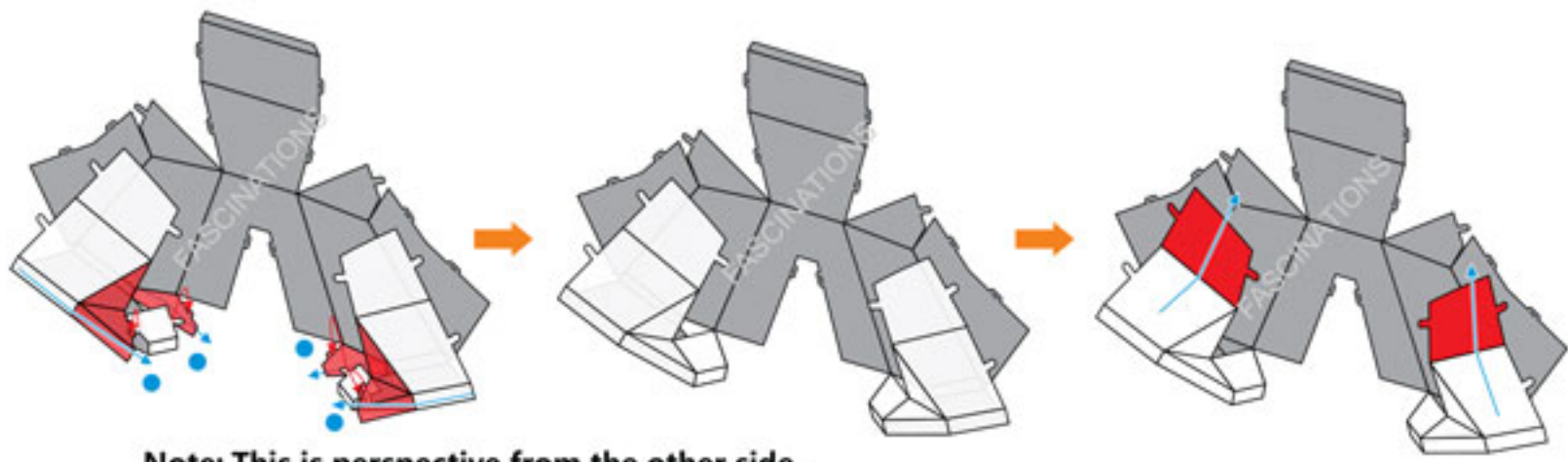

Note: This is perspective from the other side.

