

# Metal Earth. LEGENDS

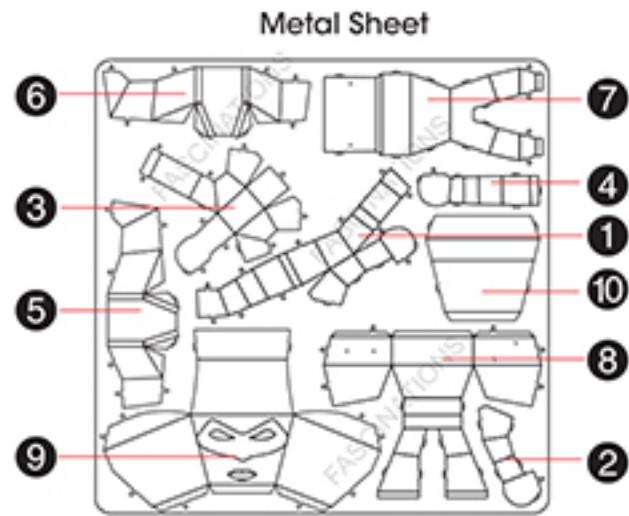

Tweezers or needle nose pliers are helpful for assembly.

Fold lines can be seen as shown here

Insertion holes

Insertion tabs are inserted and then folded or twisted

To create the best connections

- Insert tab and bend 90 degrees for most visible areas
- ▲ Insert tab and twist 90 degrees is best in some areas to ensure a tight connection

360°  
view



It is recommended that you visit [www.metalearth.com/help/mem026](http://www.metalearth.com/help/mem026) for more information when assembling this model.

⚠ In order to avoid possible injury from sharp edges, please carefully discard the metal sheet after parts have been removed

## Assembly Flow Chart

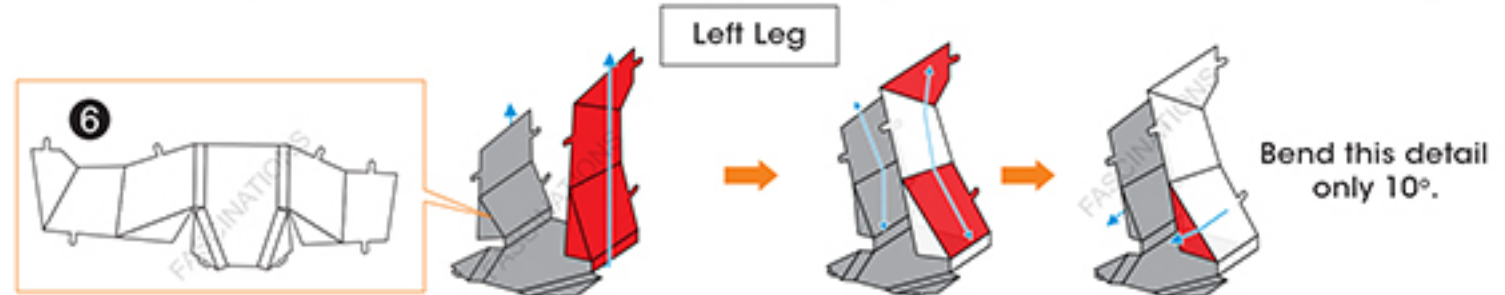
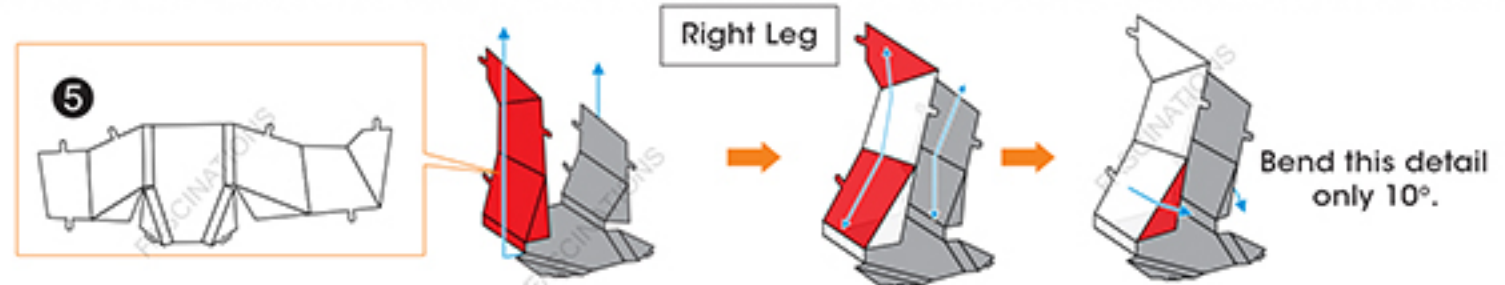
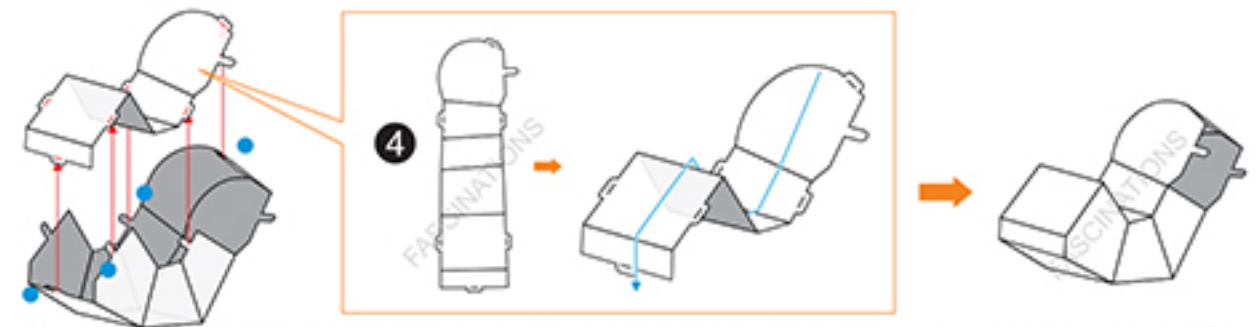
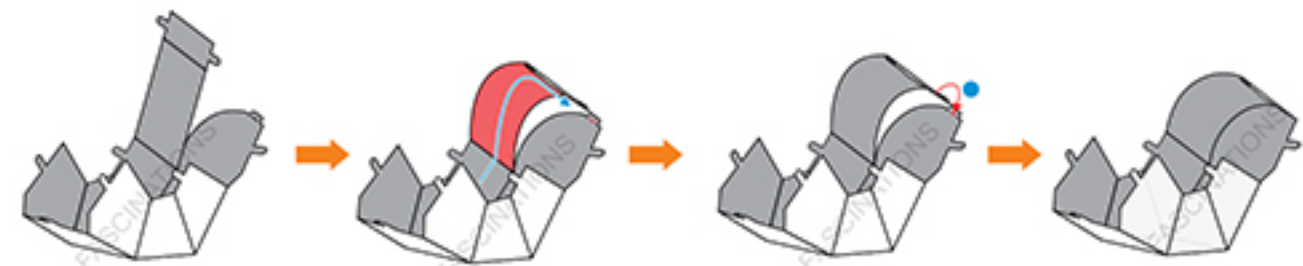
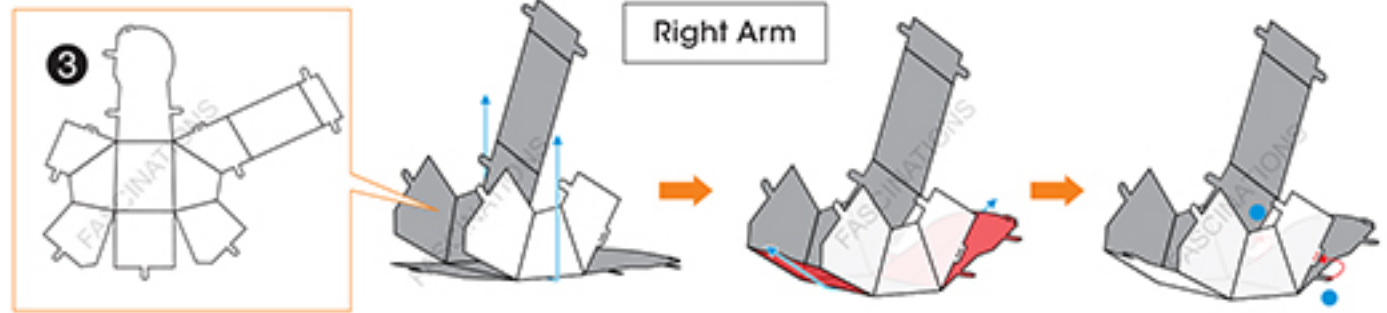
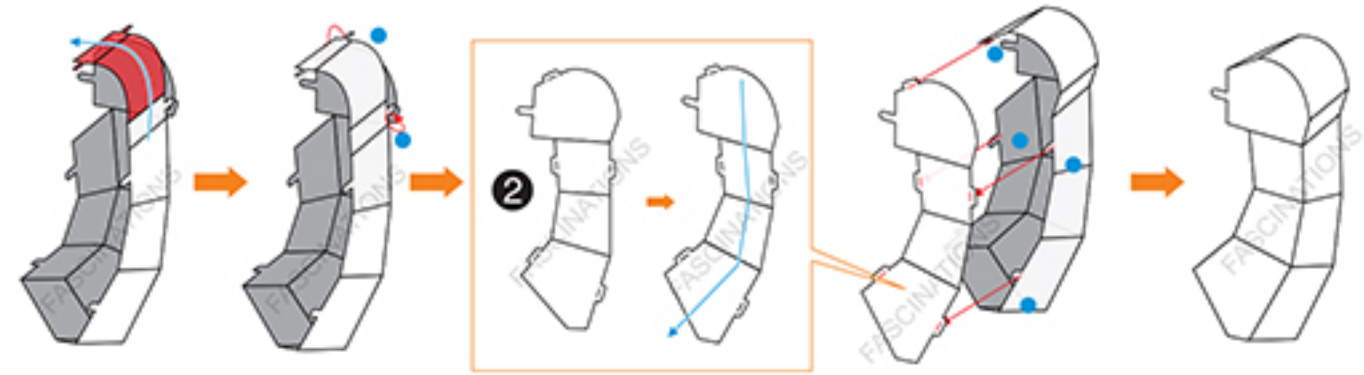
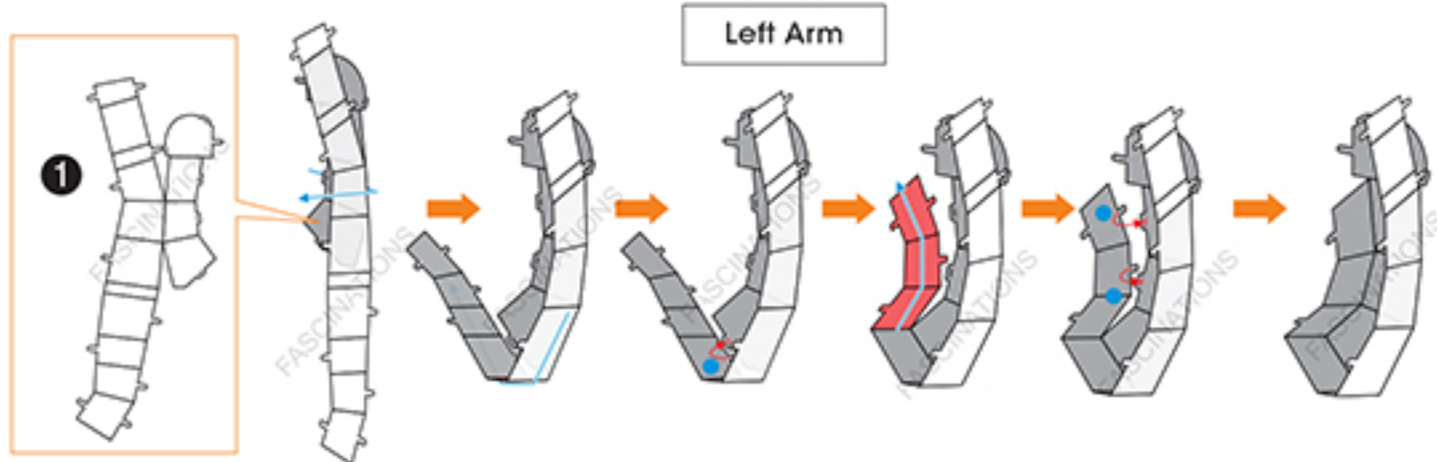

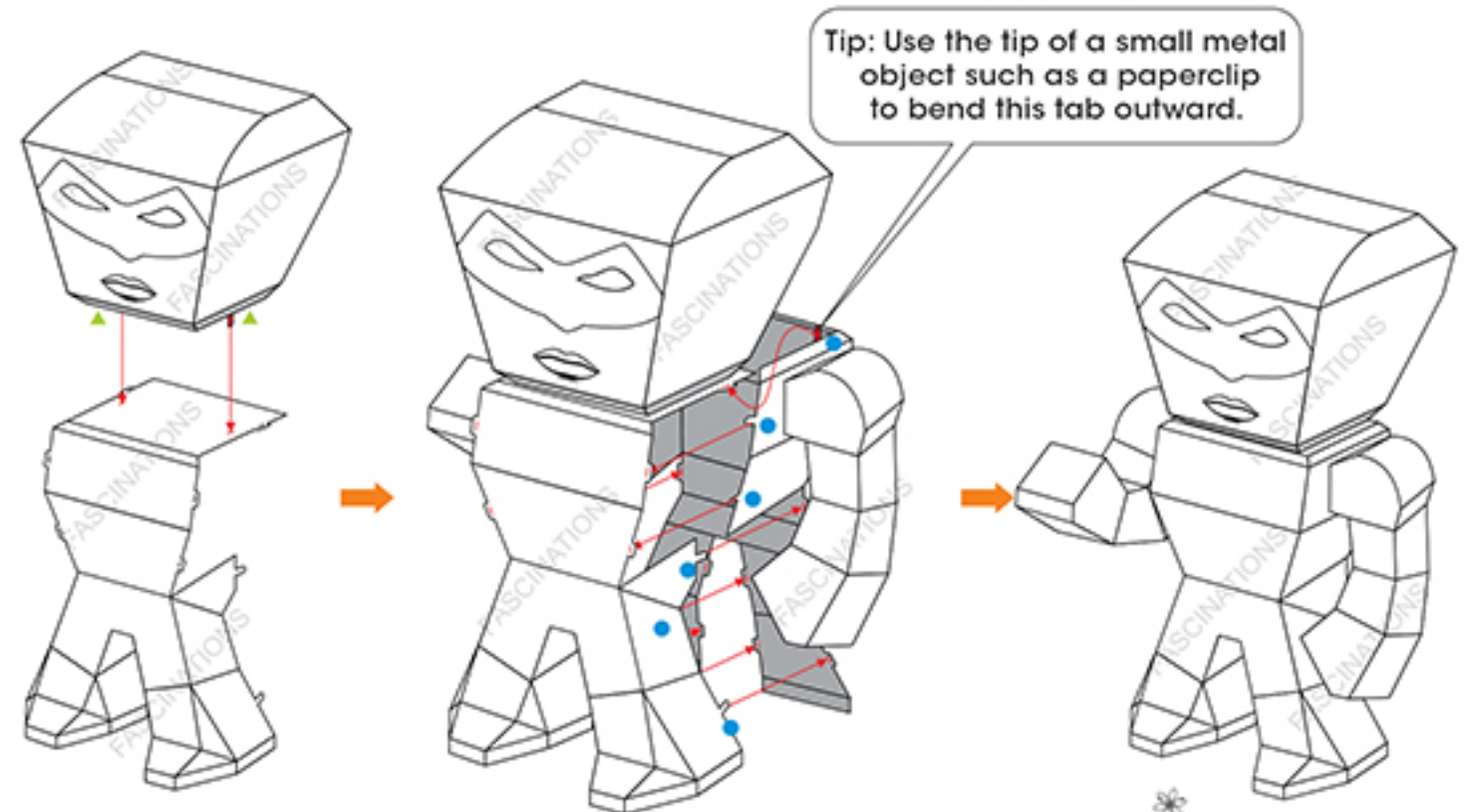
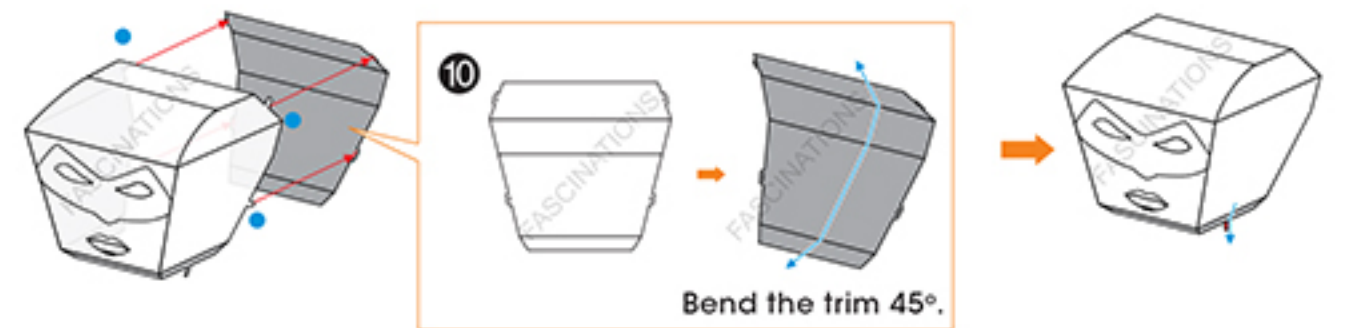
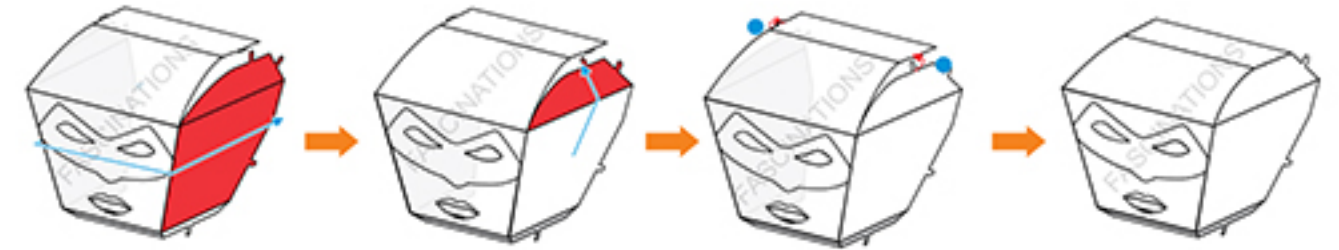
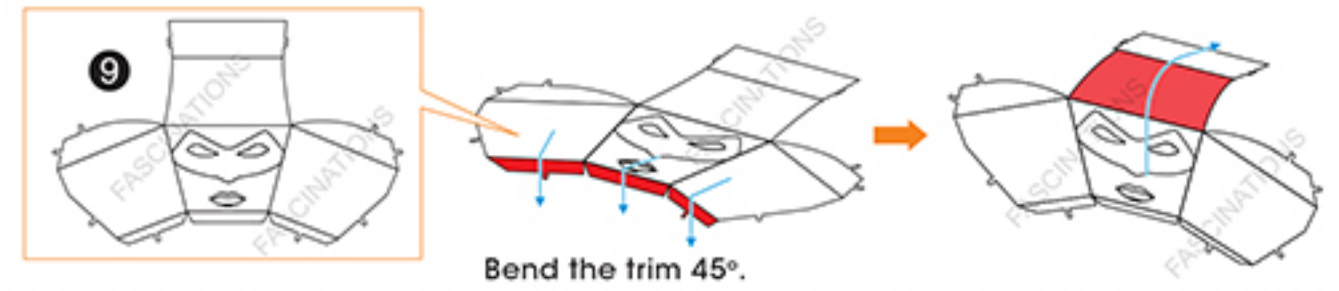
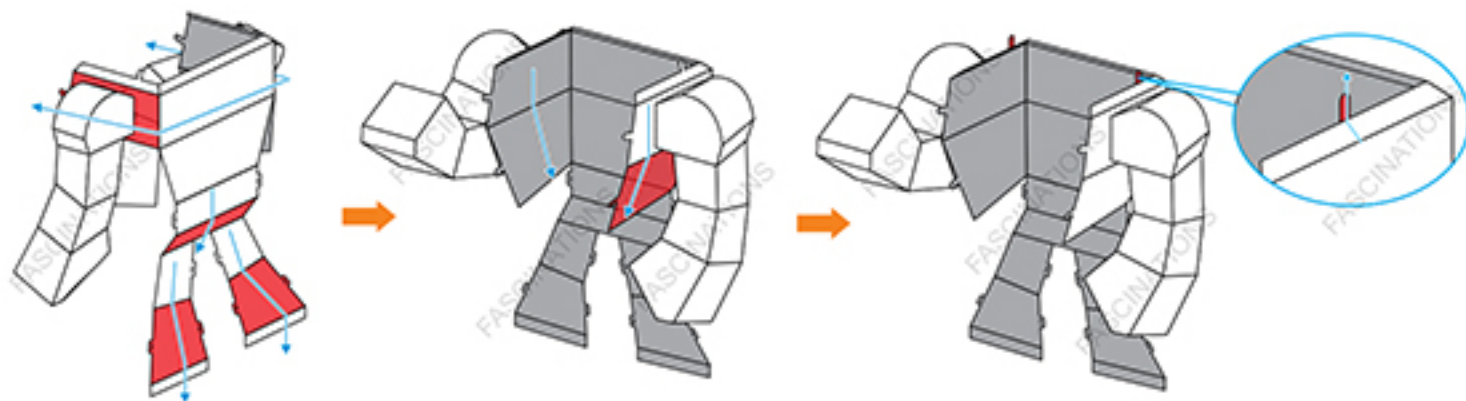
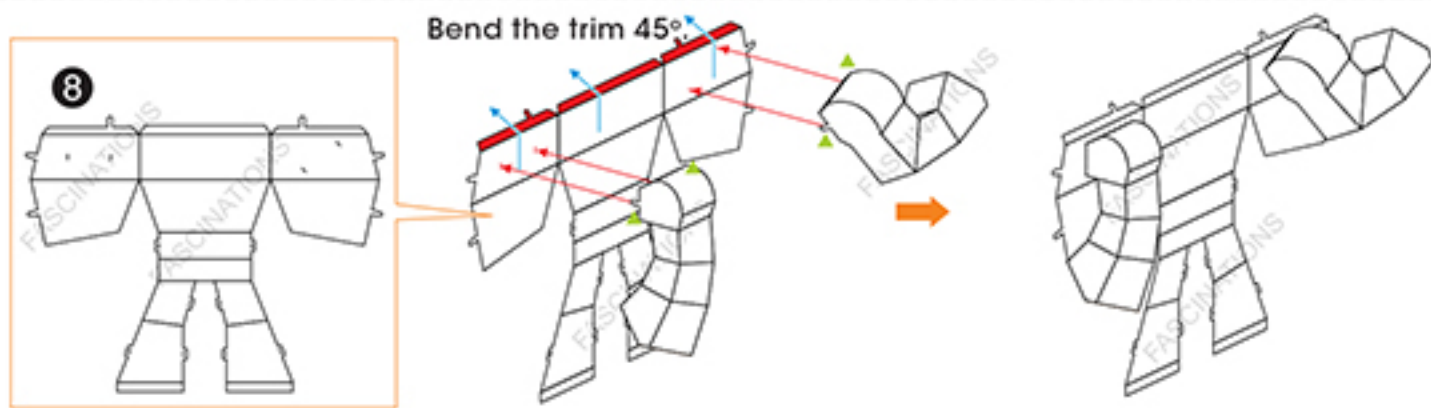
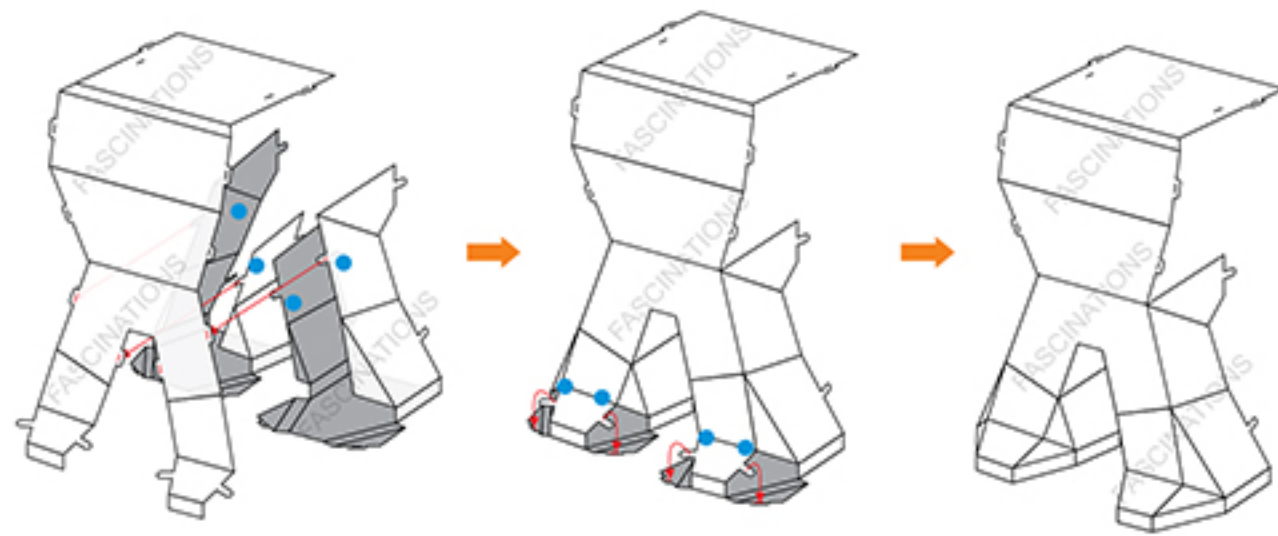
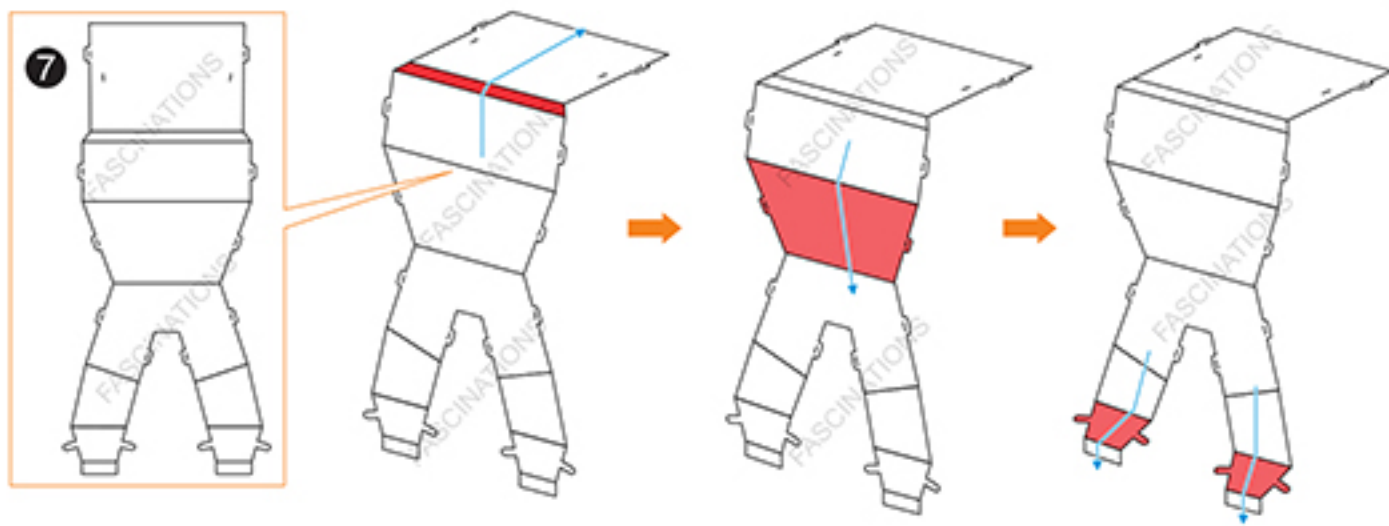

Tip: Align and lock the tabs and holes starting from the top and working your way down.